

Sollten Sie Fragen, Wünsche oder Anregungen haben, dann schreiben Sie uns eine Mail an caro@caroandjoe.com.

Gerne können Sie uns auch telefonisch unter der Nummer +41 41 780 38 08 erreichen.

Qualität:

Die Oberflächenmaterialien wurden von uns auf die Widerstandsfähigkeit gegen Tee und Alkohol (2 Stunden), Fette und Wasser (12 Stunden) getestet. Die Beschichtung ist flüssigkeitsresistent, strapazierfähig und kratzfest.

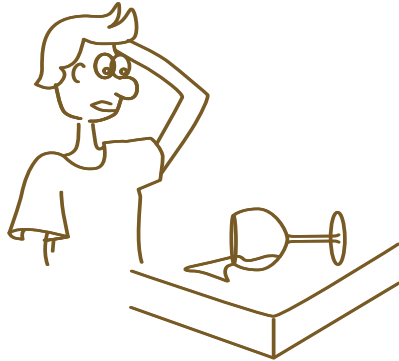

Umweltinformation:

Die zur Herstellung dieser Produkte verwendeten Materialien sind auf ihre Umwelt- und Gesundheitsverträglichkeit geprüft, absolut unbedenklich und nach deutschem Standard (E1) zertifiziert worden. Die Materialien können recycelt und zur Energiegewinnung verwendet werden.

Pflegehinweis:

Mit einem feuchten Tuch abwischen und einem trockenen und sauberen Tuch nachwischen. (Am besten nur milde und umweltfreundliche Reinigungsmittel verwenden.)



Caro, um die Schraubenköpfe zu verdecken, kannst Du einfach die beigefügten Sticker aufkleben.

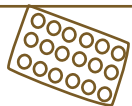
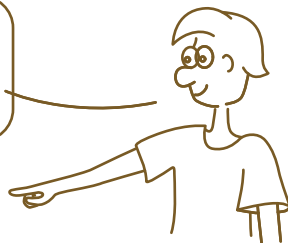

www.phoenix-home.info

ATLANTA smart living

Regal

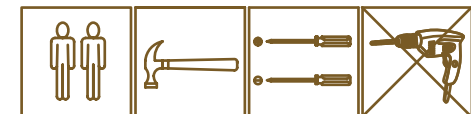
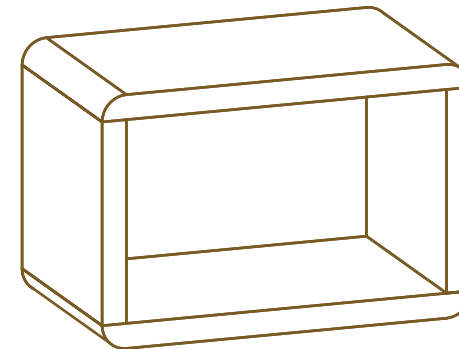
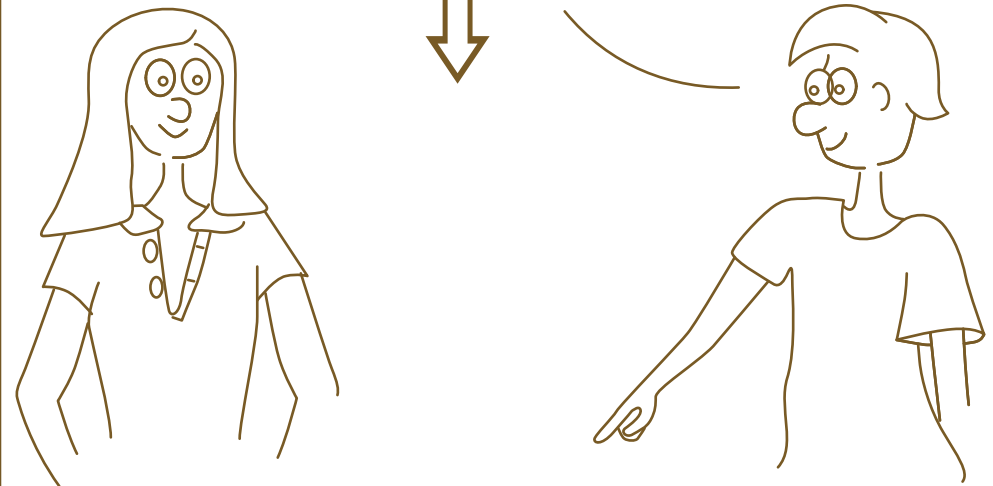

Artikel: 11 88 44

Maße: 63.7×38×42.7 cm



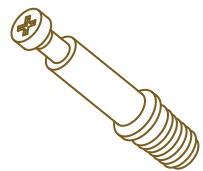

a 4x



b 4x

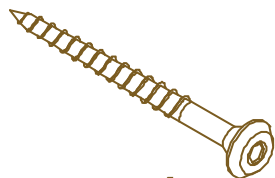

c 4x

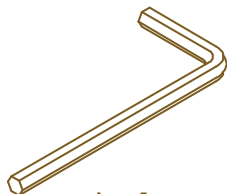

d 1x



e 4x



f 4x

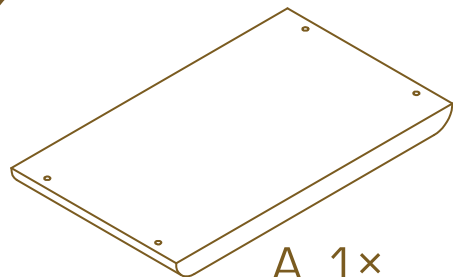

A 1x

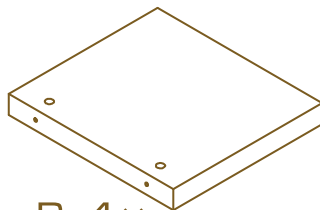

B 1x

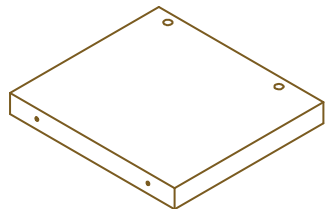

C 1x

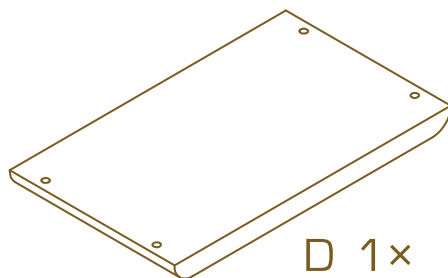

D 1x

ATLANTA smart living

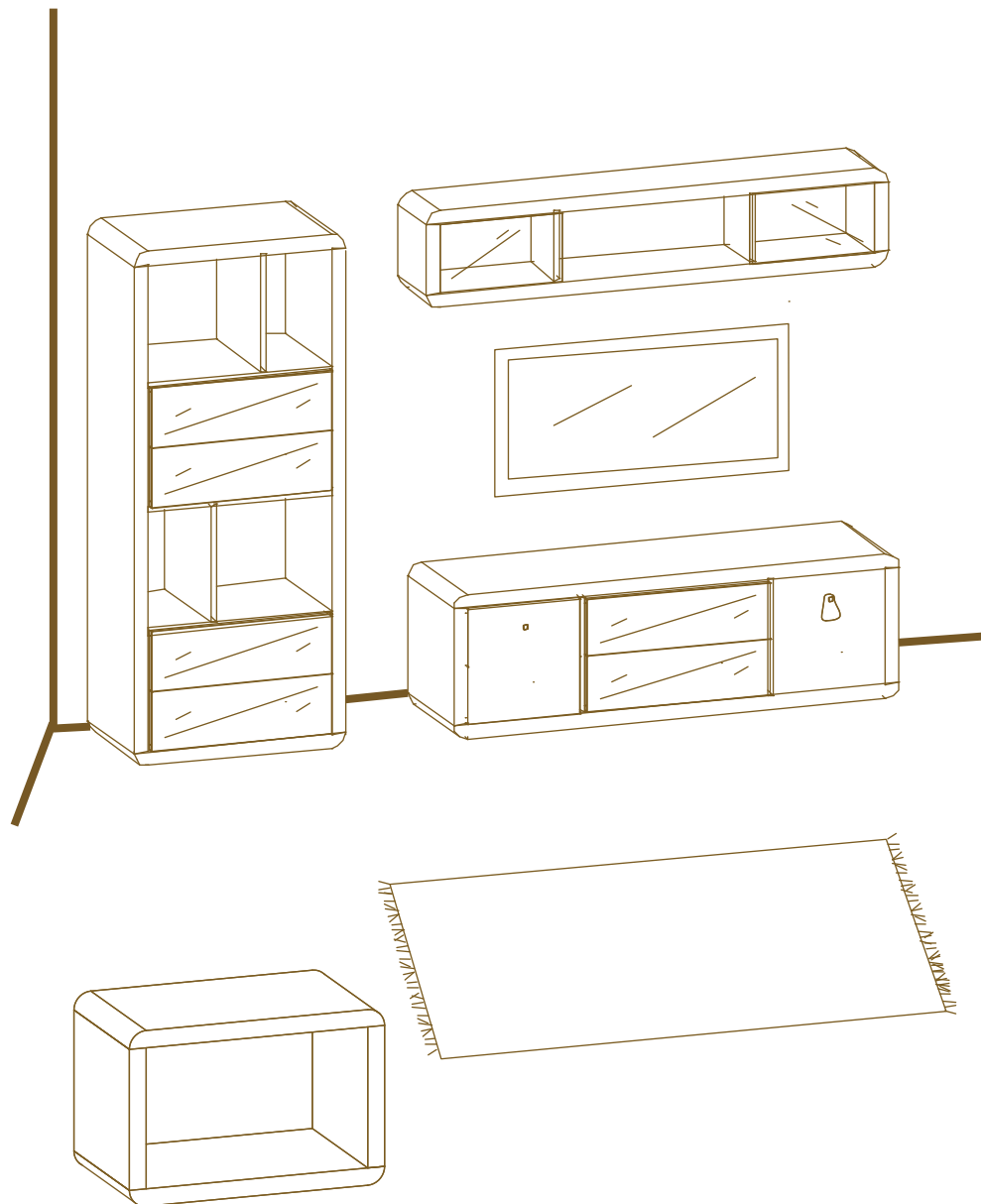

ATLANTA smart living

Wichtig:

Für späteres Nachschlagen aufbewahren!

- IMPORTANT: KEEP FOR FUTURE REFERENCE.
- IMPORTANTE: GUARDARLO PARA CONSULTARLO POSTERIORMENTE!
- IMPORTANT ! A CONSERVER POUR CONSULTATION ULTERIEURE.
- IMPORTANTE: CONSERVARE PER CONSULTAZIONI SUCCESSIVE!
- VIGTIGT: OPBEVAR TIL SENERE BRUG!
- TÄRKEÄÄ: SÄILYÄ MYÖHEMPÄÄ LUKEMISTA VARTEN!
- VIKTIGT: SPARAS FÖR SENARE BRUK!
- VIKTIG: OPPBEVARES FOR SENERE BRUK!
- ÖNEMLI: İLERIDE OKUMAK İÇİN SAKLAYINIZ!
- DÔLEŽITÉ: USCHOVAJTE PRE NESKORŠIU POTREBU!
- DŮLEŽITÉ: USCHOVEJTE PRO POZDĚJŠÍ POTŘEBU!
- FONTOS: KÉSŐBBI MEGTEKINTÉS ÉRDEKÉBEN ŐRIZZE MEG!
- TÄHTIS: HOIDA HILISEMAKS KASUTAMISEKS ALLES!
- VAŽNO: SPRAVITI ZA POZNEJŠE POISKANJE!
- VAŽNO: POHRANITI ZA POTONJE ČITANJE ZA SLUČAJ POTREBE!
- VAŽNO: SAČUVATI DA BISTE NAKNADNO MOGLI DA ČITATE AKO USTREBA!

UAE

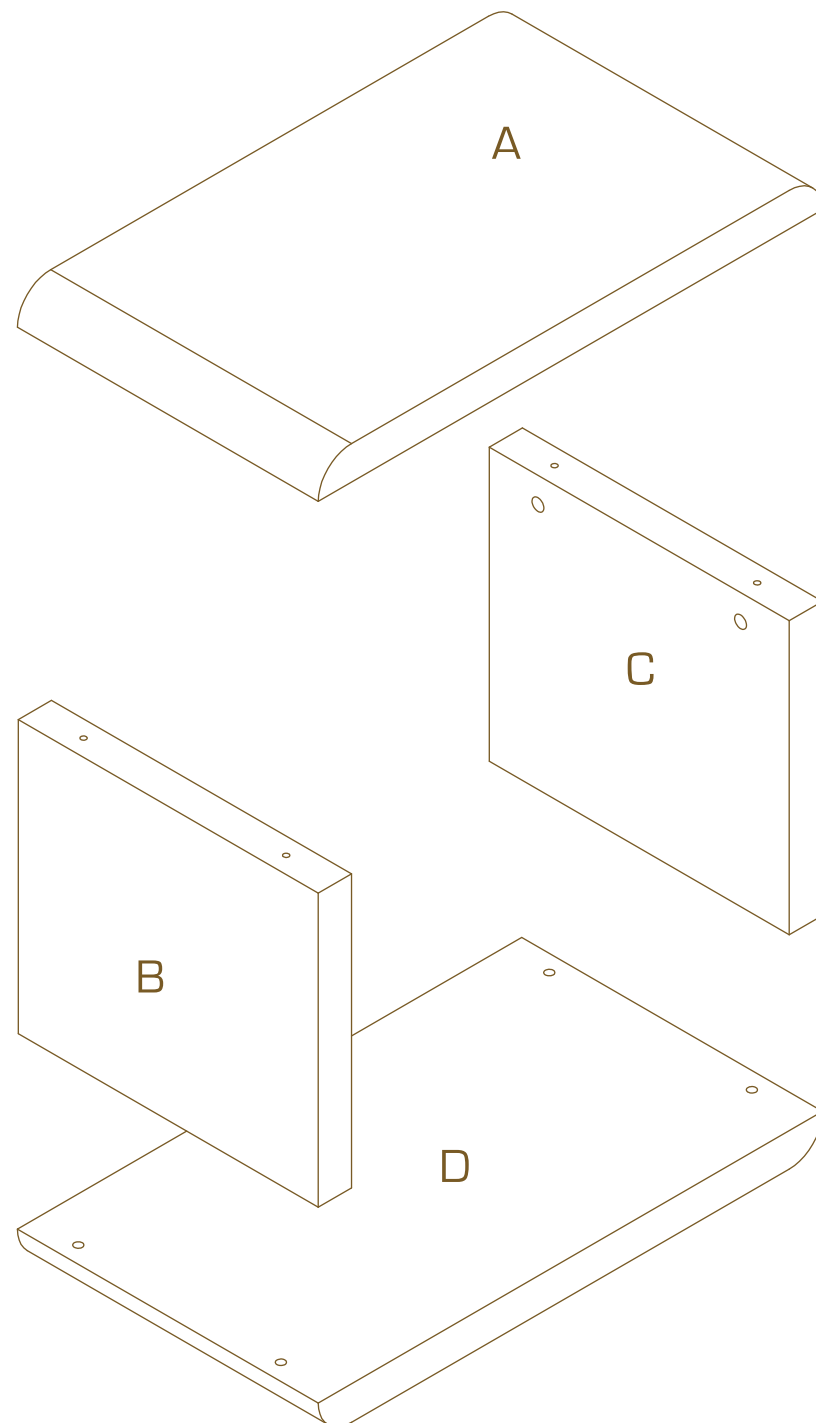

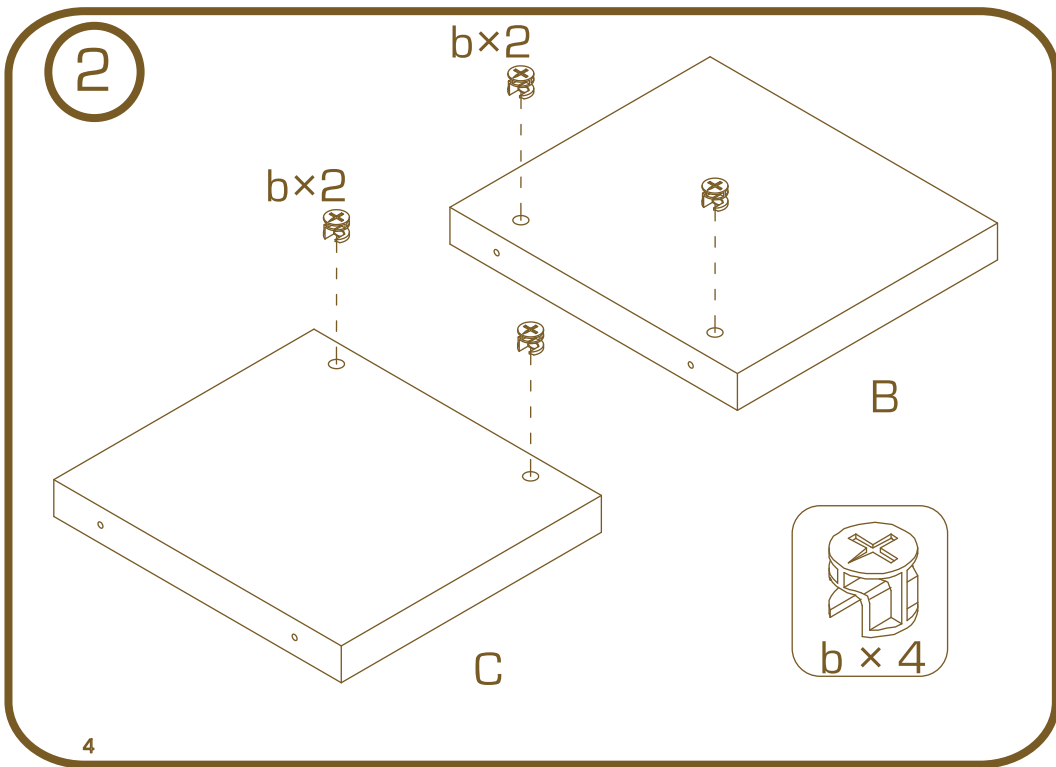
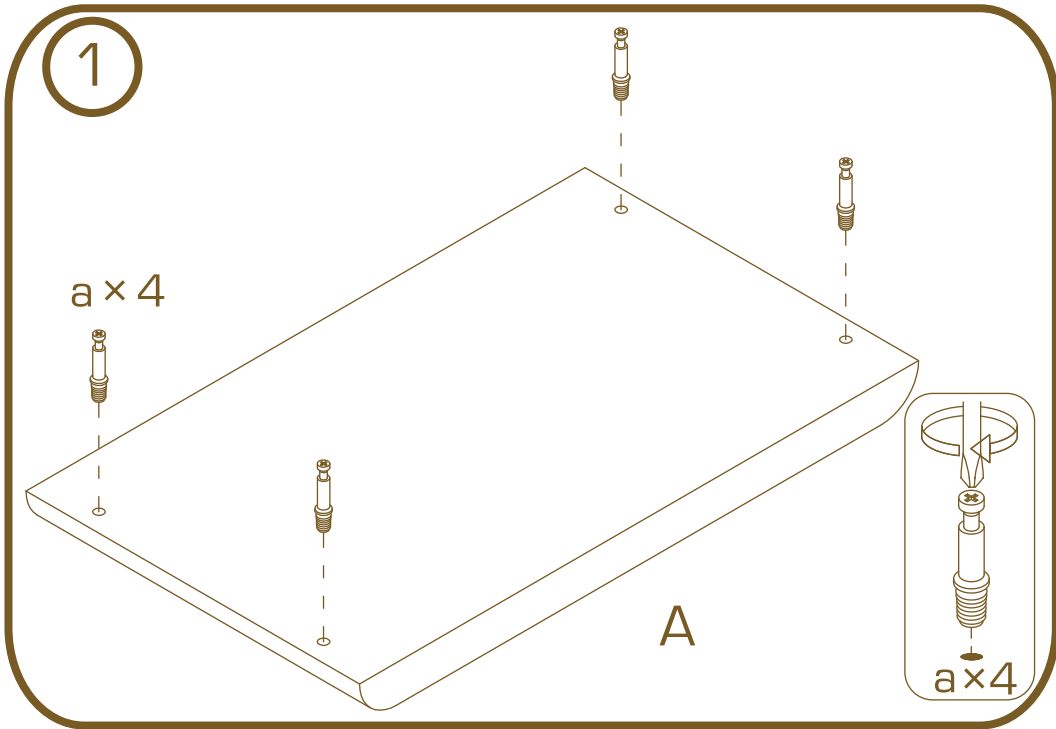

ATLANTA smart living

11 88 44 63.7x38x42.7 cm 14 88 15 42.7x35x42.7 cm

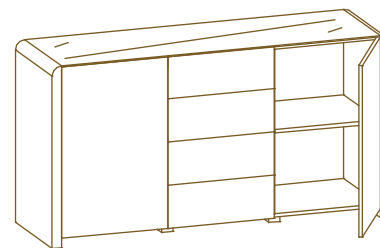

15 88 24
150.1x45x78.8 cm

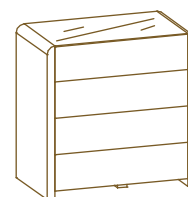

15 88 22
78.5x45x78.8 cm

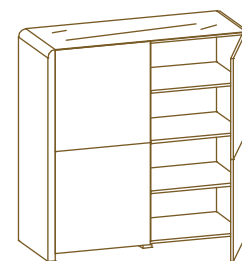

15 88 26
114.3x45x114.9 cm

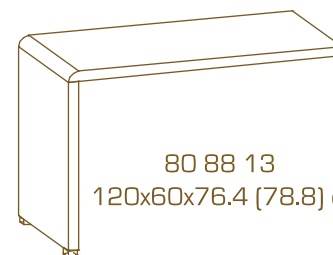

80 88 13
120x60x76.4 (78.8) cm

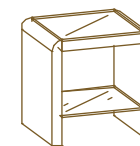
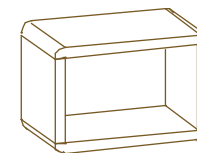

21 88 21
120x60x40 cm

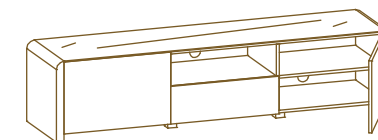

22 88 23
185.9x45x42.7 cm

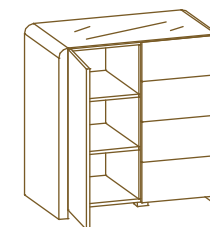

15 88 27
78.5x45x78.8 cm

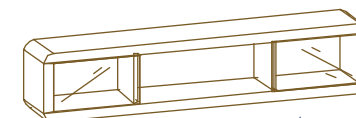

19 88 04
135.9x22x28 cm

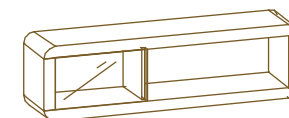

19 88 03
99.8x22x28 cm

ATLANTA smart living - Regale

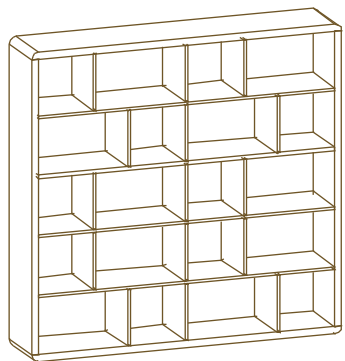

11 88 45
193x38x187.1 cm

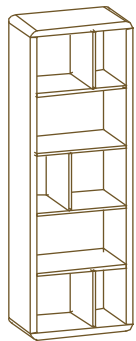

11 88 42
63.7x38x187.1 cm

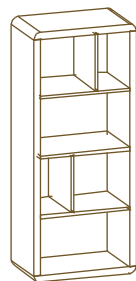

11 88 46
63.7x38x151cm

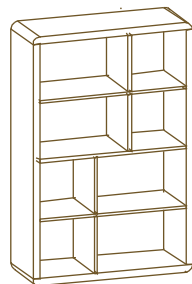

11 88 36
99.8x38x151 cm

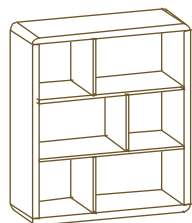

11 88 38
99.8x38x114.9 cm

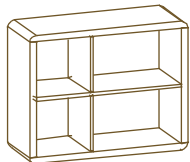

11 88 39
99.8x38x78.8 cm

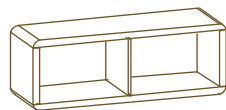

11 88 37
120.8x38x42.7 cm

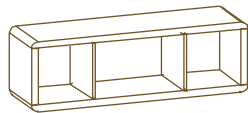

11 88 43
135.9x38x42.7 cm

ATLANTA smart living - Accessoires



81 74 03
34x38x34 cm



11 88 34
34x38x34 cm



11 88 33
34x38x34 cm



11 88 35
55x38x34 cm



11 77 06
34.2x34.2x0.5 cm

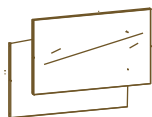

11 77 05
55.2x34.2x0.5 cm

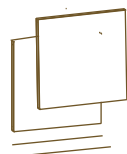

11 79 04
34.2x34x3 cm

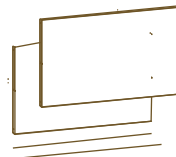

11 79 03
55.2x34x3 cm

3

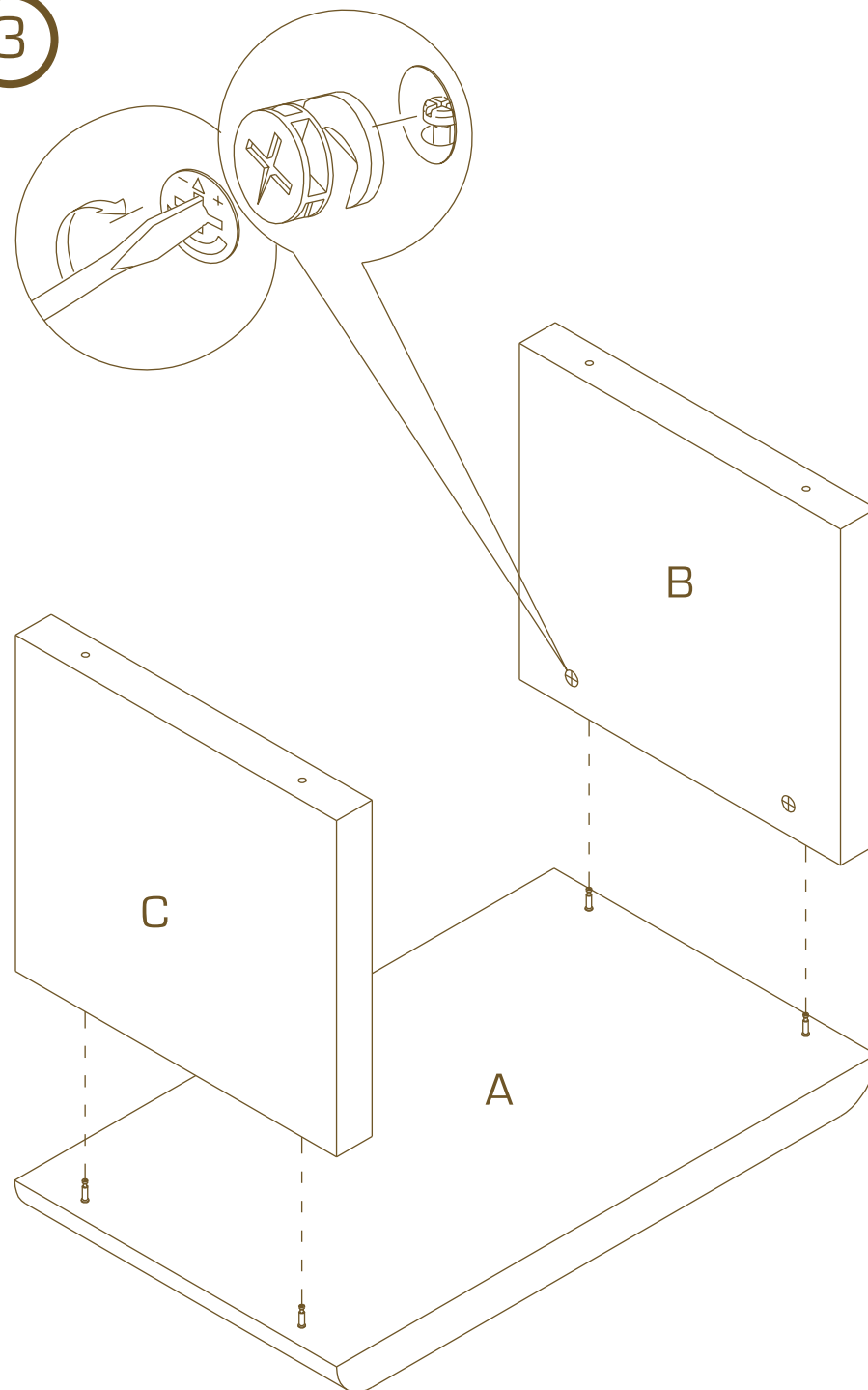

4

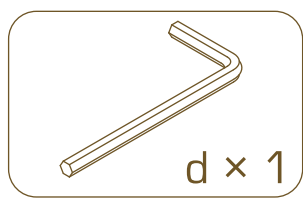
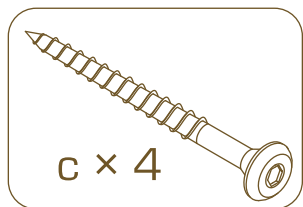
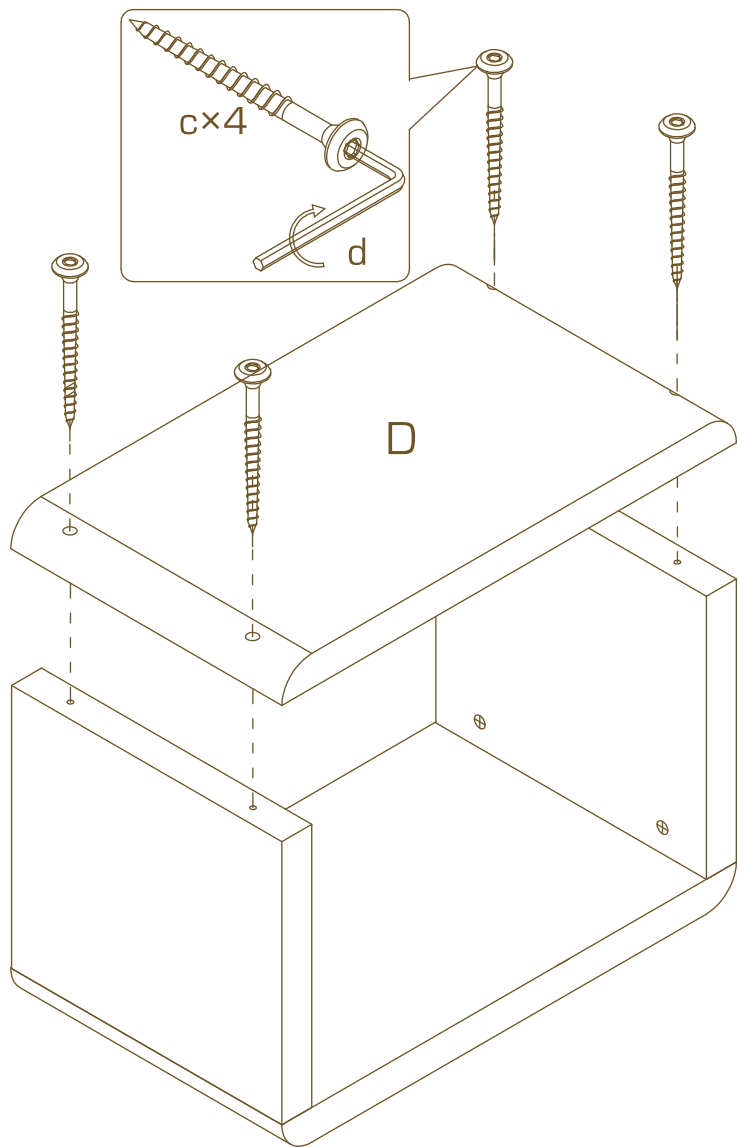

5

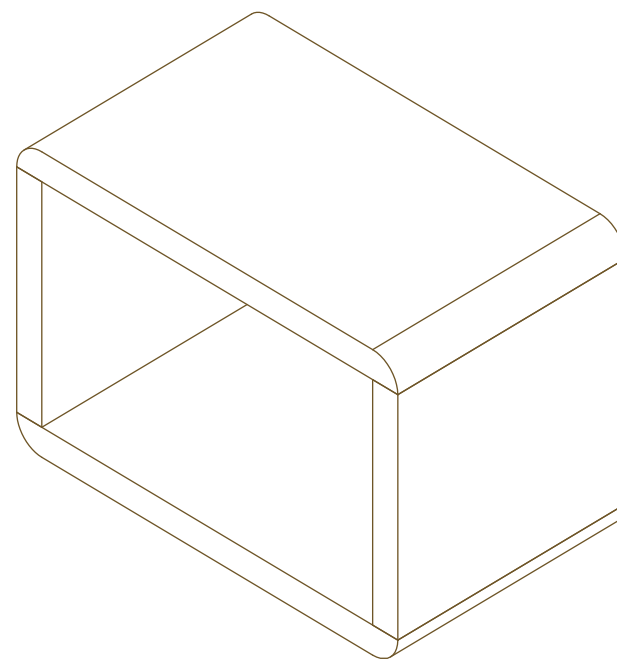
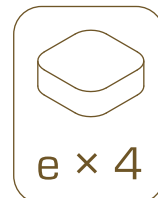
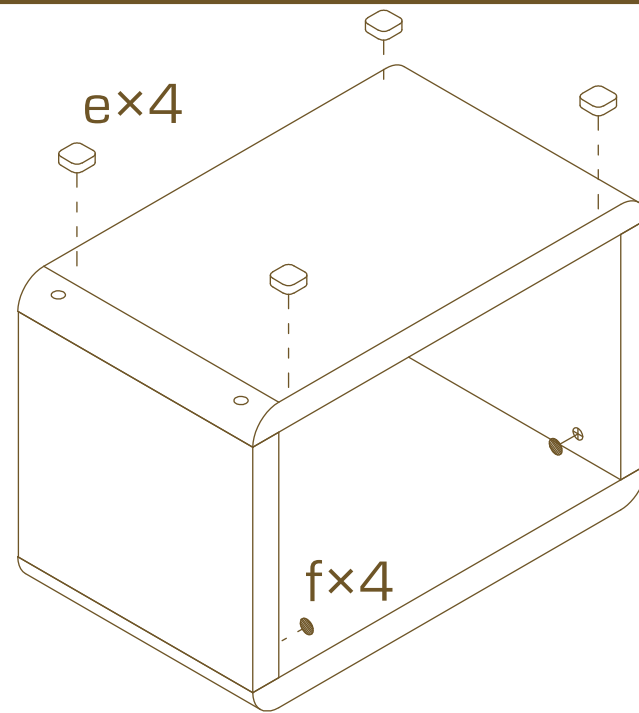

ok